

DIMENSIONS

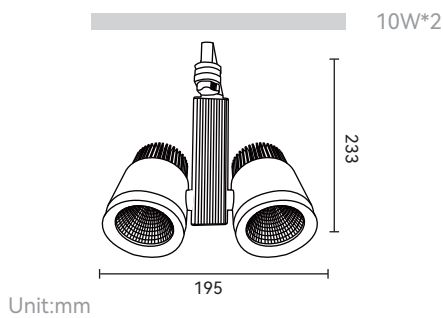

PRODUCT

NO.	ZLTR-1003-30W
LED	Epistar / Cree / Sanan
Watts	30W*2
Lumens	95lm/w
CRI	>80
Color Temperature	3000K / 4000K / 6000K
light body size	195*225*233mm
Beam Angle	24-60°
Driver	Olala
AC Input	220-240V / 50/60Hz
Color	White / Black
Installation	Surface Mounted
Storage Temperature Range	Temperature: -20°C to +50°C Humidity: 85%
Standards of Safety	EN 60598-1:2008+A11:2009 EN 60598-2-2:2012

Features:

- High-brightness led chip and high-efficiency, anti-glare and economical multi-size design, corresponding to the needs of different place.
- Secondary optical design, high light transmittance, unique PC light transmittance makes the light smooth and full.
- Secondary optical design, high light transmittance, unique PC light transmittance makes the light smooth and full.
- The spectrum does not contain red or ultraviolet light, which protects the eyes.

Application:

Widely used in museums, exhibition galleries, art galleries, restaurant, residential and commercial applications.

